



SO GIANT



OIL SEAL

SO GIANT OIL SEAL INDUSTRIAL CO., LTD.

6, Industrial East Rd, Nankang Industrial Zone,
Nantou Hsien, 54066 Taiwan R.O.C.

TEL: 886-49-2255067 (REP)

FAX: 886-49-2255407

<http://www.oilseal.com.tw/>

<http://www.sog.com.tw/>

E-mail: bzy@sogiant.com.tw



2009.9.14-00
Nantou Hsien, Taiwan R.O.C. TEL: 886-49-2255067

SO GIANT



OIL SEAL



PRODUCT :
SHAFT SEALS
WIPER SEALS
BONDED SEALS
V-SEALS
O-RINGS
BOOTS
RUBBER PARTS

MATERIAL :
NBR
POLYACRYLATE
EPDM
NEOPRENE
SILICONE
FPM
PTFE

SO GIANT OIL SEAL INDUSTRIAL CO., LTD.

6, Industrial East Rd, Nankang Industrial Zone,
Nantou Hsien, 54066 Taiwan R.O.C.

TEL: 886-49-2255067 (REP) FAX: 886-49-2255407

<http://www.oilseal.com.tw/> <http://www.sog.com.tw/>

E-mail: bzy@sogiant.com.tw



THE BUREAU OF STANDARDS, METROLOGY AND INSPECTION (BSMI),
MINISTRY OF ECONOMIC AFFAIRS, TAIWAN, R.O.C.
QUALITY MANAGEMENT SYSTEM CERTIFICATE

ISO 9001
BSMI

認可登錄
REGISTERED

hereby certifies that the firm

SO GIANT OIL SEAL INDUSTRIAL CO., LTD.

(6, INDUSTRIAL EAST RD., NANTOU CITY, NANTOU HSIEN, TAIWAN, R.O.C.)

has fulfilled the requirements of Quality Management System
specified as

ISO 9001:2008/CNS 12681

and is granted registration by the Bureau.
The scope of registration is described below.

THE PRODUCTION OF:

* OIL SEAL

OFF-SITE(S) INCLUDE:

SO GIANT OIL SEAL INDUSTRIAL CO., LTD. FACTORY II (11, INDUSTRIAL EAST RD.,
NANTOU CITY, NANTOU HSIEN, TAIWAN, R.O.C.) ---end---

Originally Registered:	April 29, 1997
Date of Approval:	June 4, 2009
Expiry Date:	June 3, 2012
Certificate No:	5M4Y036-07

Jay-san Chen

Jay-San Chen, Ph. D.
Director General



Quality Management
QC 002



QMS 010

Scopes accredited by the TAF are marked with “*”



經濟部標準檢驗局
品質管理系統驗證證書

ISO 9001
BSMI

認可登錄
REGISTERED

茲證明

嵩贊油封工業股份有限公司

(地址：南投縣南投市工業東路6號)

實施 ISO 9001:2008/CNS 12681 品質管理系統
經本局評鑑結果符合標準予以認可登錄範圍如下：

下列項目生產：

*油封

評鑑區域另包含：

二廠（南投縣南投市工業東路11號）

(以下空白)

原始登錄日期：	中華民國	86年04月29日
發證日期：	中華民國	98年06月04日
有效期限：	中華民國	101年06月03日
驗證證書編號：	5M4Y036-07	

局長 陳介山



Quality Management
QC 002



QMS 010

加註*者為取得財團法人全國認證基金會(TAF)之認證範圍



Welcome to



SO GIANT OIL SEAL INDUSTRIAL CO., LTD.

ISO 9001 BSMI Certificate No. 5M4Y036

So Giant was founded in 1988, ample resources was linked, professional and well trained personnel was grouped.

TEAM work approve the exaggerative growth. In the past 20 years, over 20000 different tools was developed, for which build a solid foundation of SOG seals.

Quality concept and high efficiency team performance promote the SOG's products to the globe with ISO 9001 Quality Standard.
To eminent in your market, SOG is Your best choice !

Information /Trade Conditions

Company Policy :
Customer First
Concept Leading
Competition Growth
Properties : Professional Manufacturer
Export Market : Global market
Percentage Exports : 90%
Minimum Order : Negotiable
Lead Time : 40 days
Payment Terms : L/C, D/P, T/T
Factory Area : 8700m²
Staff : 110

Address : No.6 Industrial East Road,
Nankang Industrial Zone,
Nantou 54066, Taiwan, R.O.C.

Tel : 886-49-2255067
Fax : 886-49-2255407
<http://www.oilseal.com.tw/>
<http://www.sog.com.tw/>
E-mail: bzy@sogiant.com.tw

PRODUCT :
SHAFT SEALS
WIPER SEALS
BONDED SEALS
V-SEALS
O-RINGS
BOOTS
RUBBER PARTS

MATERIAL :
NBR
POLYACRYLATE
EPDM
NEOPRENE
SILICONE
FPM
PTFE

SO GIANT OIL SEAL



Contents

1. Introduction

2. SOG Products

- 2-1 Oil seals for industries and vehicles
 - 2-1.1 Charts of SOG designs for oil seals
 - 2-1.2 Interchange for popular designs
- 2-2 Bonded seals
- 2-3 Wiper seals
- 2-4 O-ring
- 2-5 C.V. boots
- 2-6 V-seal
- 2-7 U-seal

3. Sealing Elements

- 3-1 Nitrile rubber
- 3-2 Polyacrylate rubber
- 3-3 Silicone rubber
- 3-4 Fluorinated rubber

4. Tolerance Tables

- 4-1 Press fit tolerance of seal outer diameter in inch and millimeter
- 4-2 Width tolerance of seals
- 4-3 Press fit allowance and permissible eccentricity of seal outer diameter in millimeter



1. Introduction

So Giant Oil Seal Industrial Co., Ltd. was established by a group of young men in 1988 who have the common views and philosophy. SOG has talented workers who come from different fields with expertise in technology, marketing and MIS. These experts formulate and computerize management, finance and sale, step by step.

We manage all processes from purchase of material to production tracking system, from sales information to the account audits in our MIS system. This computerized management has raised each department efficiency, competitiveness, and productivity.

In addition, we have simplified our organization and made operating processes simpler and more accurate. This is a quality assurance to you. All computer software is designed in house. For this reason, the set-up of the computer is fast and close to the need of the customer and SOG. We have assembled extensive resources and drive ourselves hard.

To succeed in your market, SOG is your best choice!

SO GIANT OIL SEAL INDUSTRIAL CO., LTD.

6, Industrial East Rd, Nankang Industrial Zone,
Nantou Hsien, 54066 Taiwan R.O.C.

TEL: 886-49-2255067 (REP)
FAX: 886-49-2255407
<http://www.oilseal.com.tw/>
<http://www.sog.com.tw/>
E-mail: bzy@sogiant.com.tw



2. SOG Products

2-1 Oil seals for industries and vehicles

Oil seals are used for rotating shafts. SOG offer a comprehensive range of oil seals for industries and vehicles.

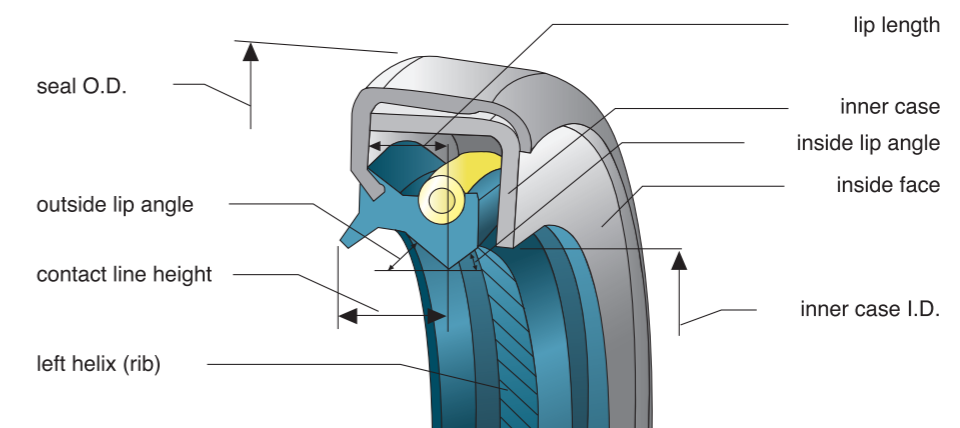
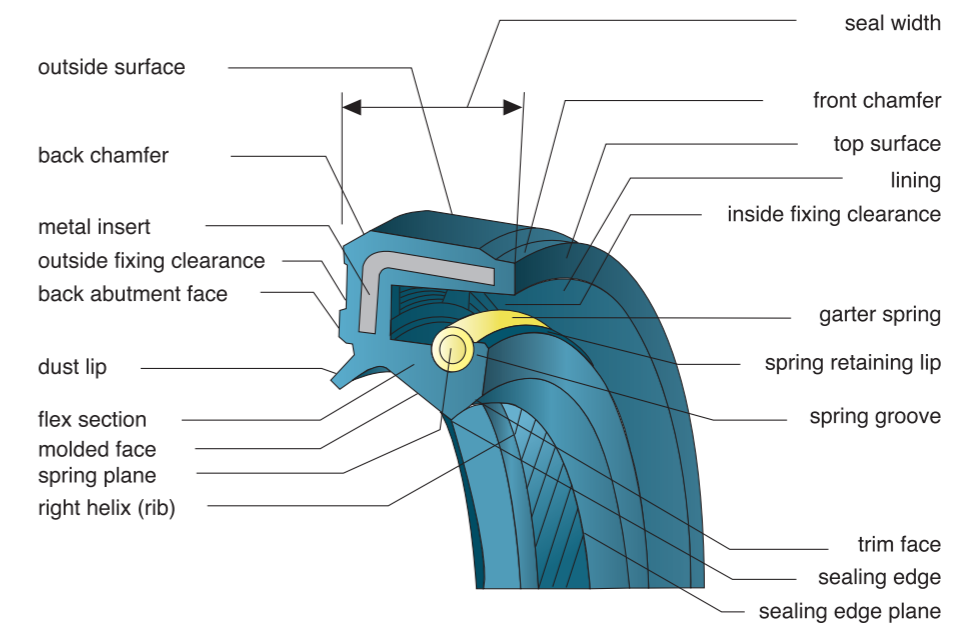

Rising Star Award

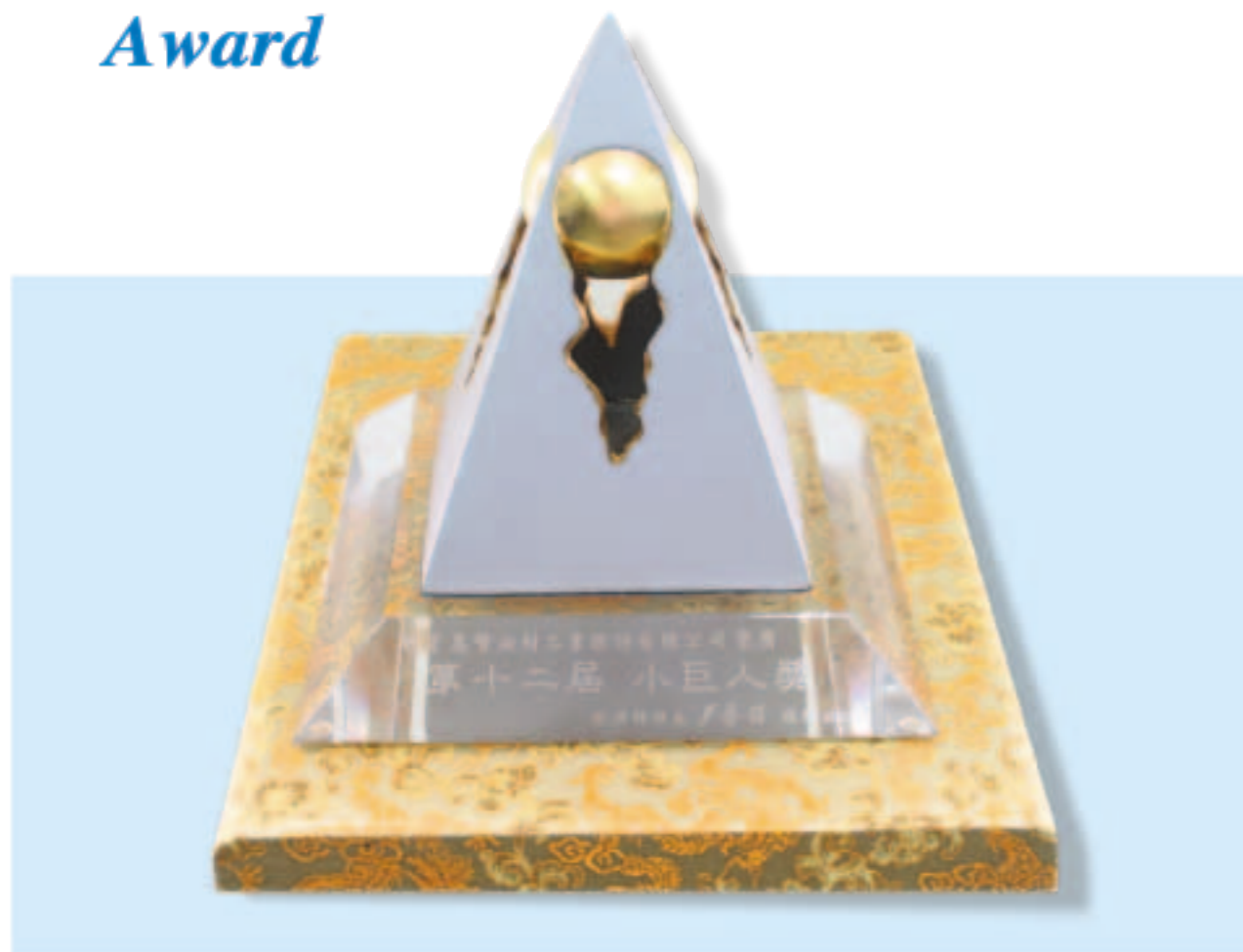

The spirit embodied in the Rising Star Award

The Little Giant Award is also named the Rising Star Award because it implies a forever bright future as the Sun constantly rises in the East.

It is designed as a pyramid to represent the structure of Taiwanese domestic industries is based on the solid foundation laid by more than 98% of the local hard-working small and medium enterprises. The trophy also features a golden ball contained within to express the award winner from enterprises as a shining star, who is insightful, pragmatic, vigorous and determined to break through whatever blocks him as a giant always does.

小巨人獎 獎座精神

小巨人獎座命名為「昇」，即旭日東昇之意。

整體造型外觀，呈金字塔形，代表台灣產業的構造，是由98%以上的中小企業，一直在默默耕耘，奠定了穩固基礎。獎座上另呈現破裂狀，內部出現一個金球，代表了獲獎企業有如閃閃耀耀的明日之星，不但具有遠見並持續不斷努力，象徵小巨人的活力四射與突破艱困的爆發力。



經濟部小巨人獎證書

嵩贊油封工業股份有限公司
積極開拓國際舞台，在國際市場上具高度競爭力，且企業經營管理健全，足堪作為中小企業表率，經評選榮獲第12屆小巨人獎，特頒此證，以資表揚。

經濟部 尹啓銘
部長

中華民國 98年 8月 26日



CERTIFICATE

-On the Honor of the 12th Rising Star Award-

Issue Date: August 26, 2009

This Certificate of the 12th Rising Star Award is officially conferred upon *So Giant Oil Seal Ind. Co., Ltd.* in recognition of its exceptional efforts in developing itself into the global community and its successful achievement of remarkable competitive edge in the global market under its sound and remarkable management. It is universally acknowledged as a shining model role to all SMEs, deserving the commendation conferred hereupon.

Yin Chi-ming

Minister, Ministry of Economic Affairs, R.O.C.





SO GIANT OIL SEAL

2-1.1 Charts of SOG designs for oil seals
Designs of rubber outer diameter

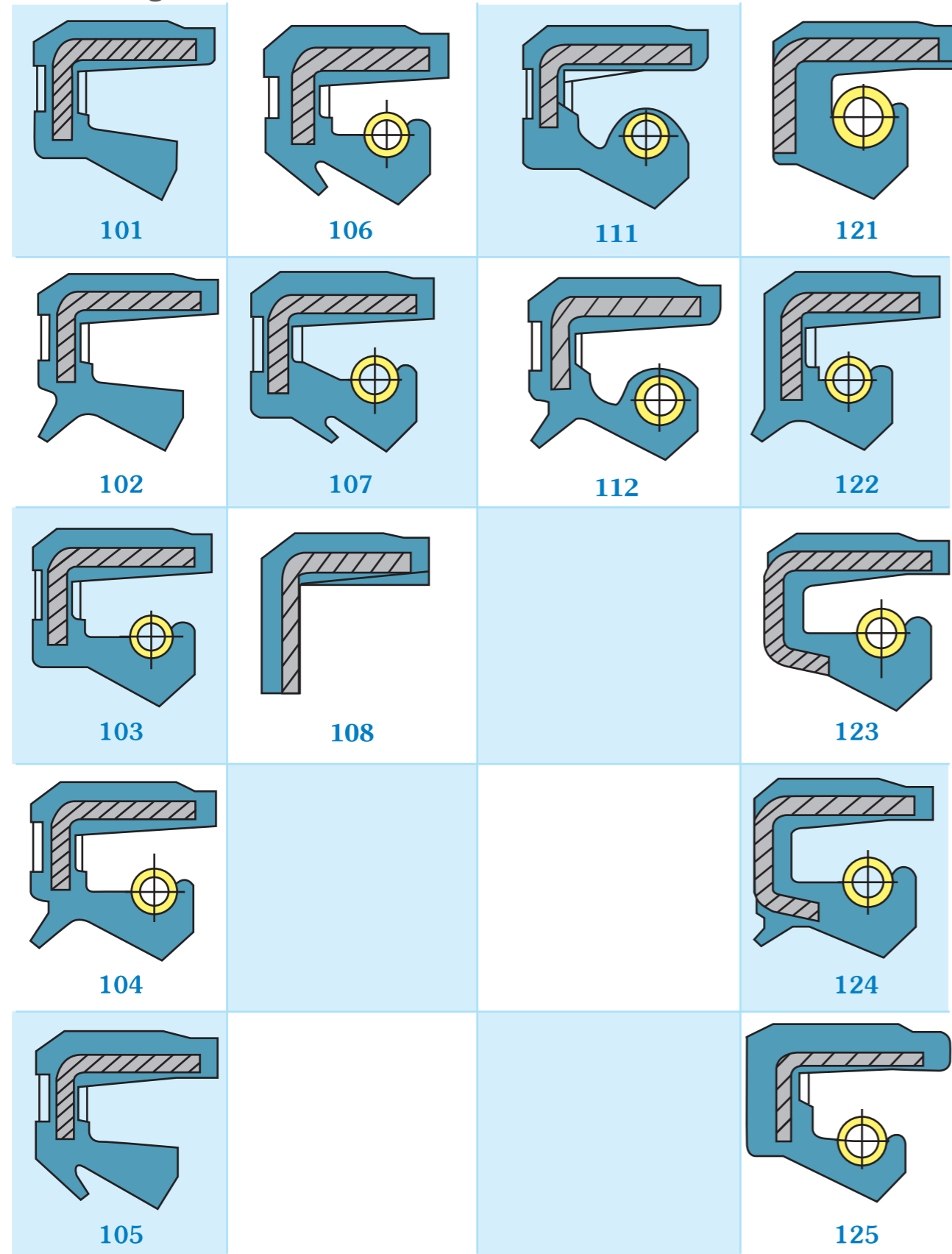

SO GIANT OIL SEAL

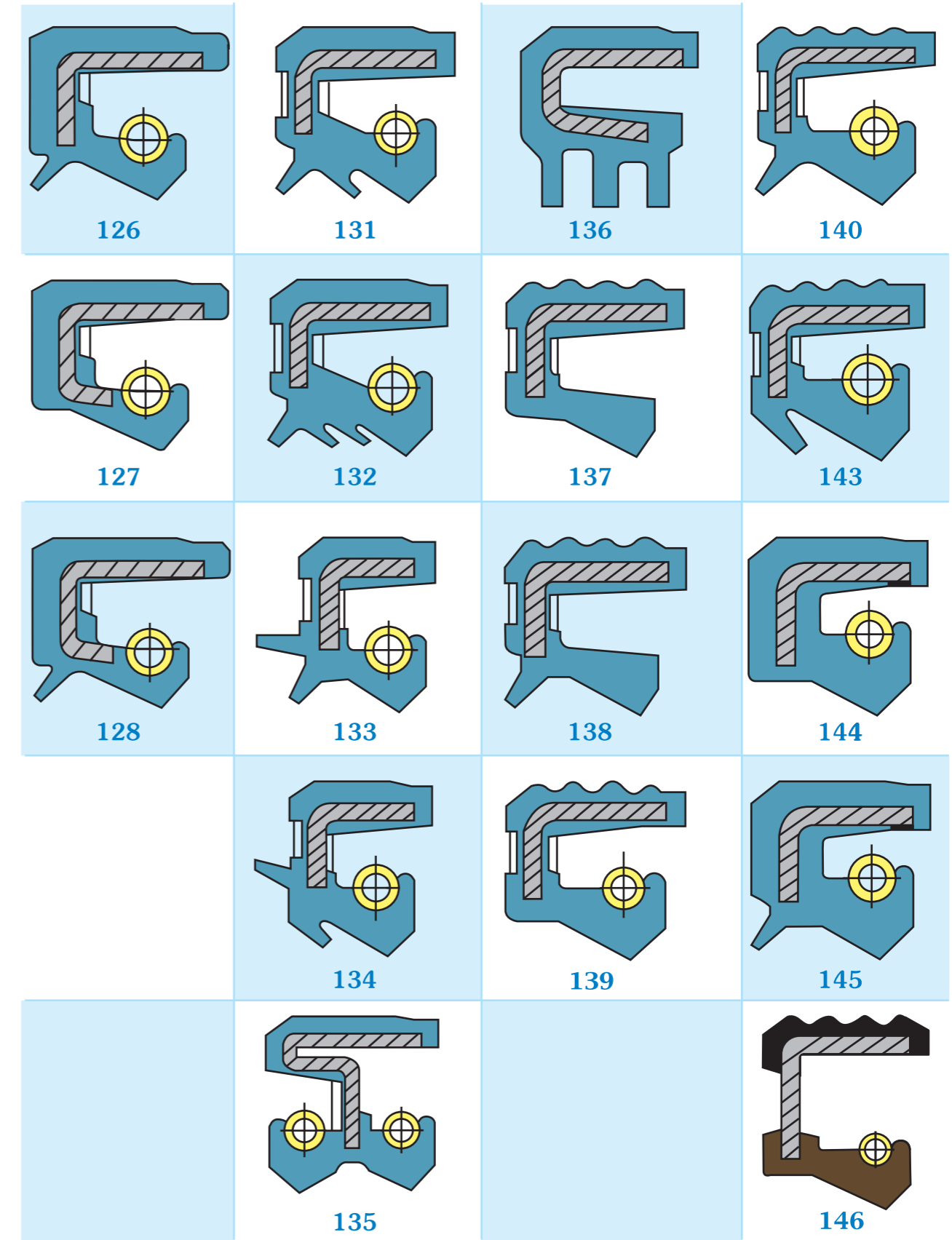



SO GIANT OIL SEAL

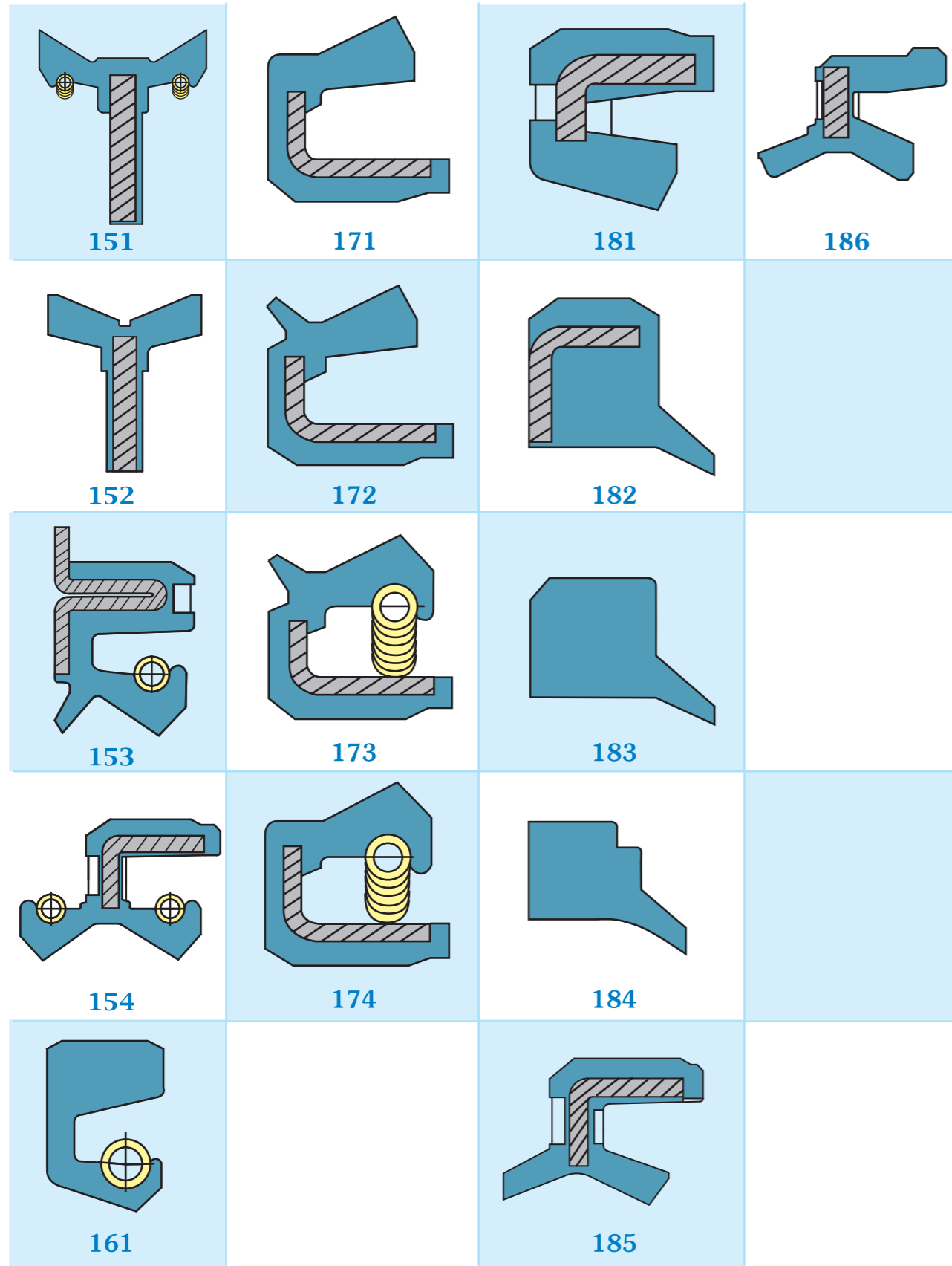

SO GIANT OIL SEAL

Designs of metal outer diameter

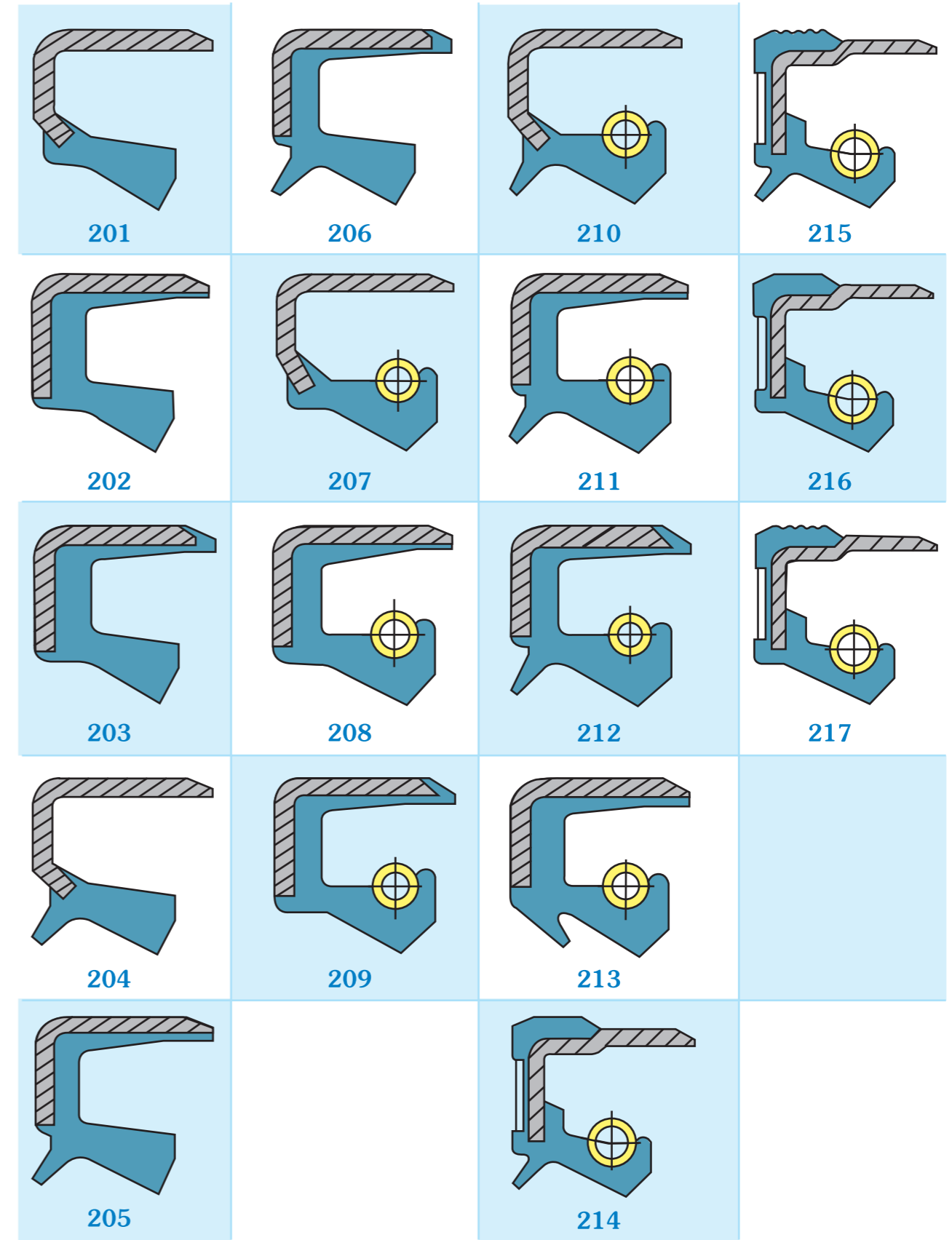



SO GIANT OIL SEAL

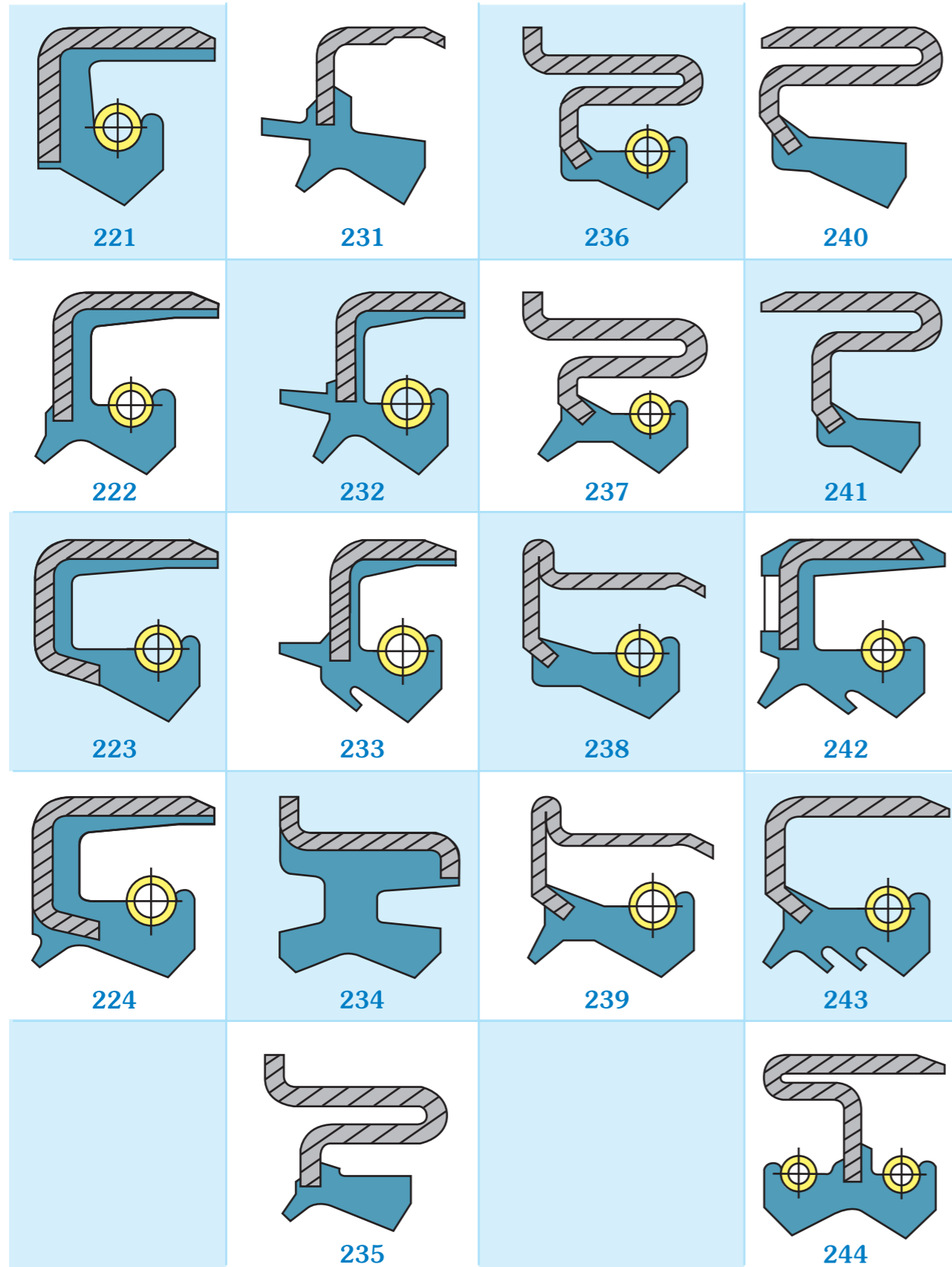

SO GIANT OIL SEAL

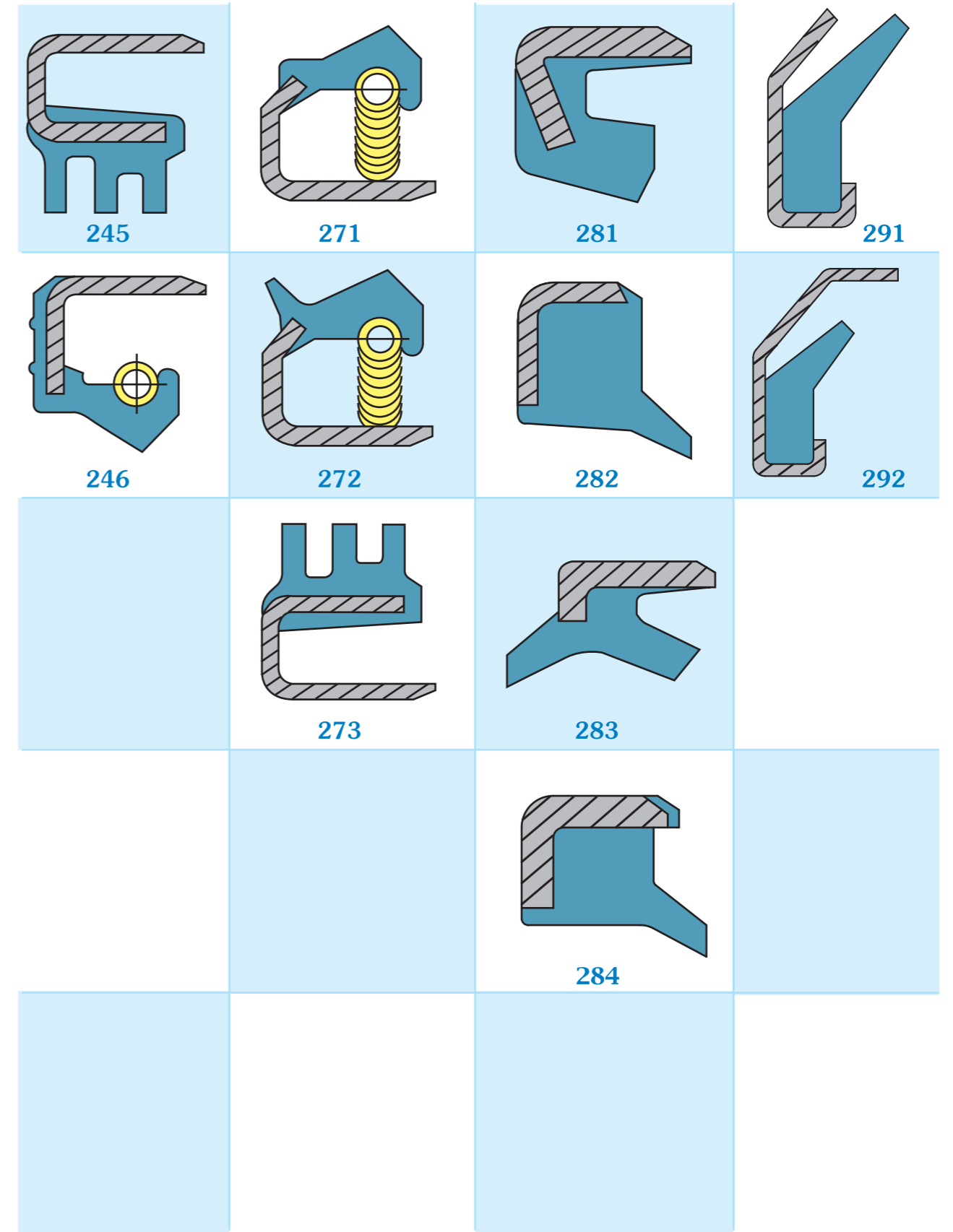



SO GIANT OIL SEAL

Designs of metal outer diameter with inner case

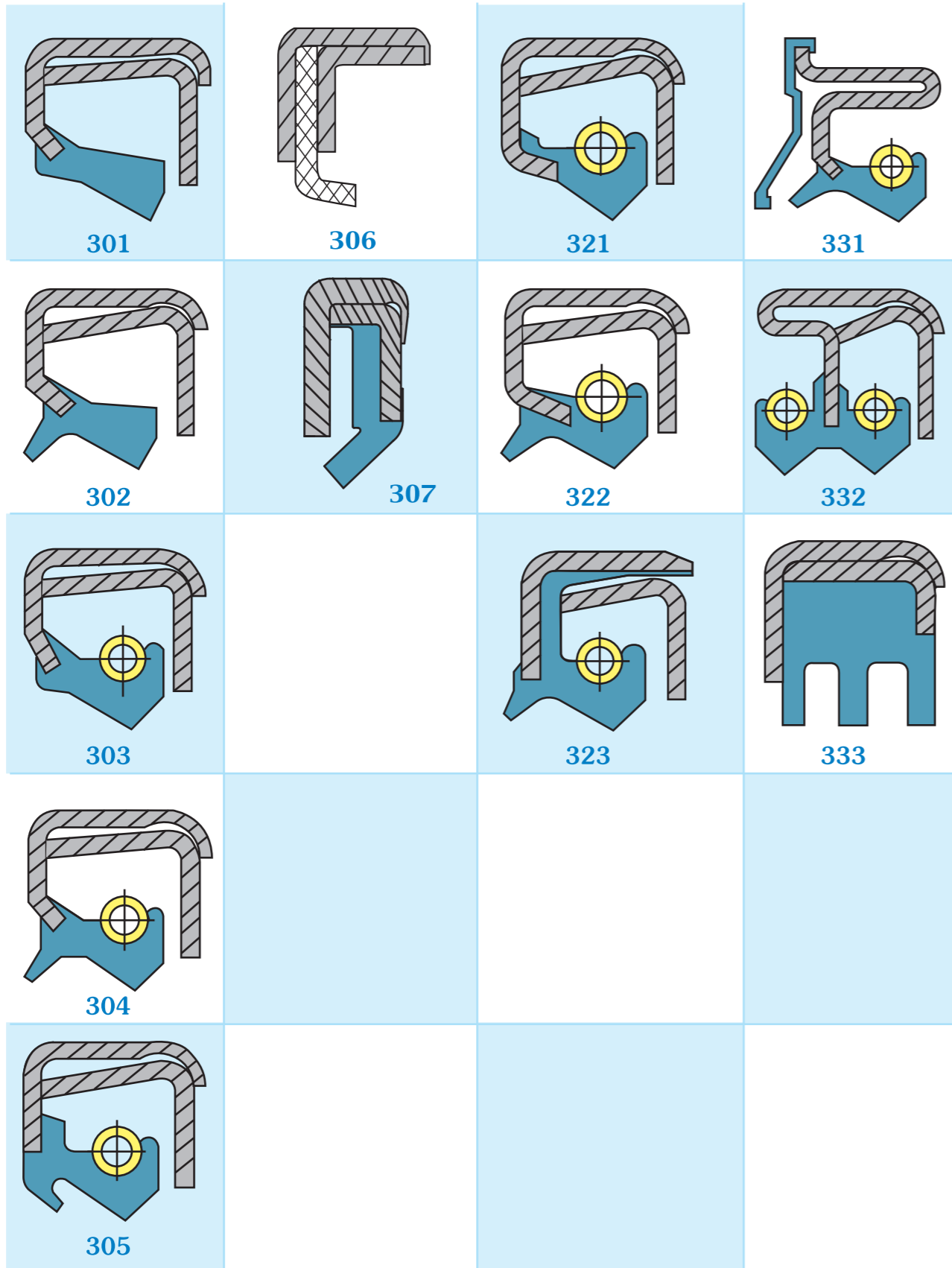

SO GIANT OIL SEAL

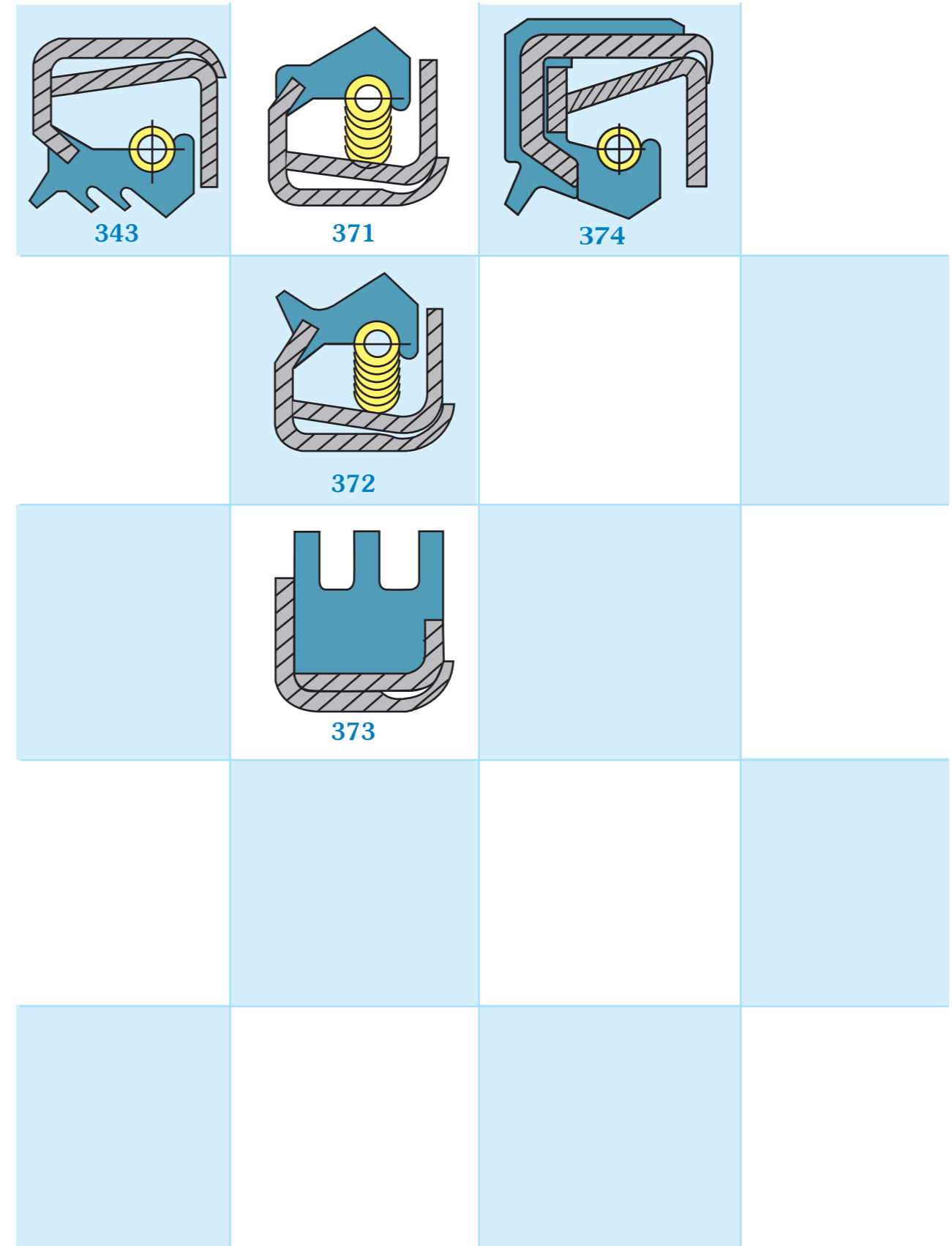



SO GIANT OIL SEAL

2-1.2 Interchange for popular designs

SO GIANT	103	104	207	210	303	304
DIN 3760	A	AS	B	BS	C	CS
CFW	BA	BASL	B1	B1 SL	B2	B2 SL
GOETZE	827N	827S	822N	822S	824N	824S
KACO	DG	DGS	DF	DFS	SFK	DFSK
STEFA	CB	CC	BB	BC	DB	DC
NOK	SC	TC	SB	TB	SA	TA

2-2 Bonded seals

The bonded seals is a static seals which are used as a sealing ring fitted under bolt heads and nuts. In order to avoid any damage on the sealing lip, the inside diameter of bonded seals should be larger than the external thread diameter and the rubber should be bonded to the inside metal only.

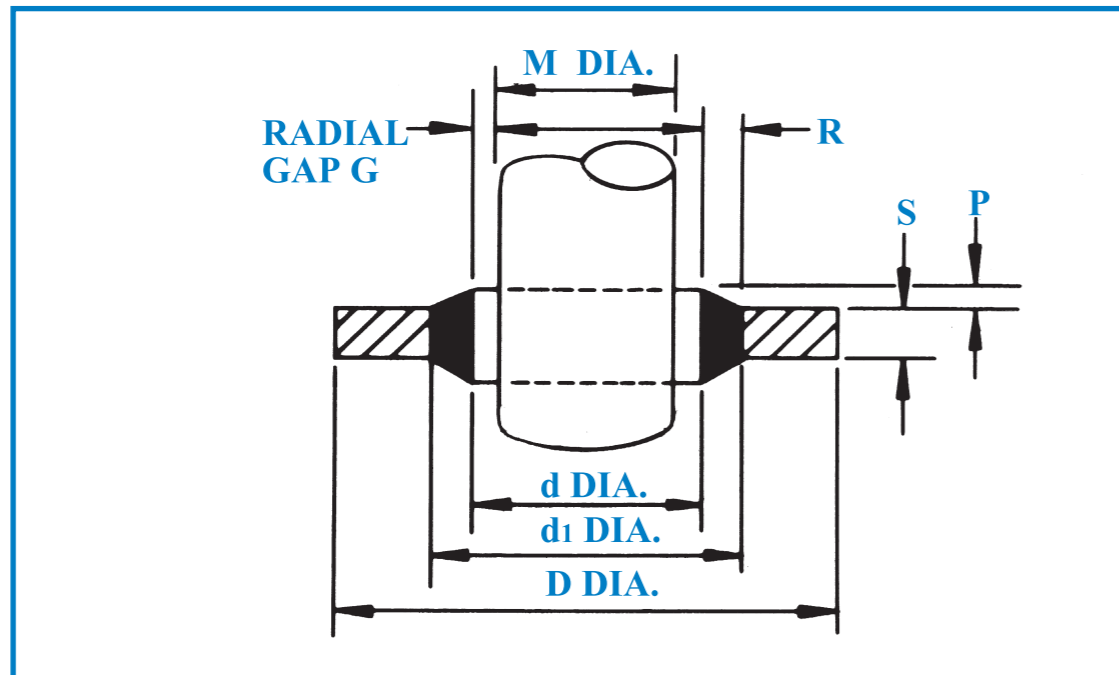

SO GIANT OIL SEAL

2-3 Wiper seals

Wiper seals are made of nitrile rubber, general in 90 shore a, for press-in fitting in open housings. The SOG type 182 has metal insert for reinforcement and type 282 has an external metal case. Our standard designs as Bellow.

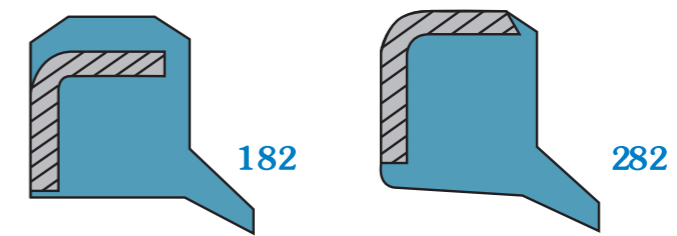

2-4 O-ring

O-rings is one of most popular sealing products. SOG existing toolings include all O-rings in accordance with AS568A. Also, We supply metric sizes.

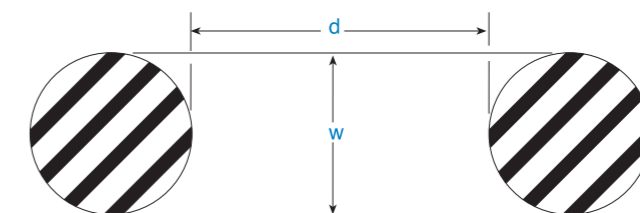

2-5 C.V.boots

All C.V. joints are mounted in protective synthetic rubber boots used to retain lubrication and prevent outside contaminants from reaching the working surfaces of the joints

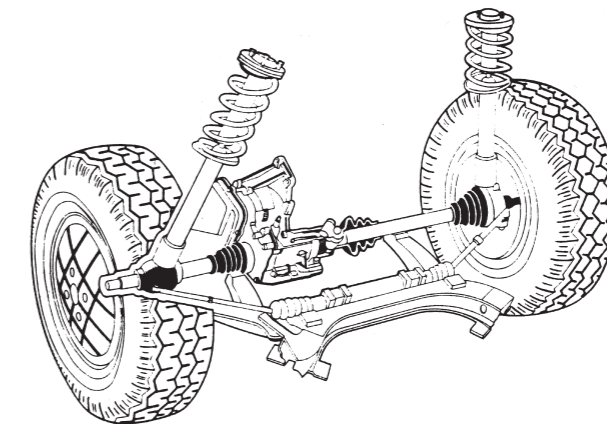

2.6 V-seal

V-seal, with a low friction axial and flexible lip, is an interference fit on a rotating shaft when it is essential to protect bearing or machine parts from grease, dust and other contaminants. The lip of V-seal is against the counter face to create the sealing function.





SO GIANT OIL SEAL



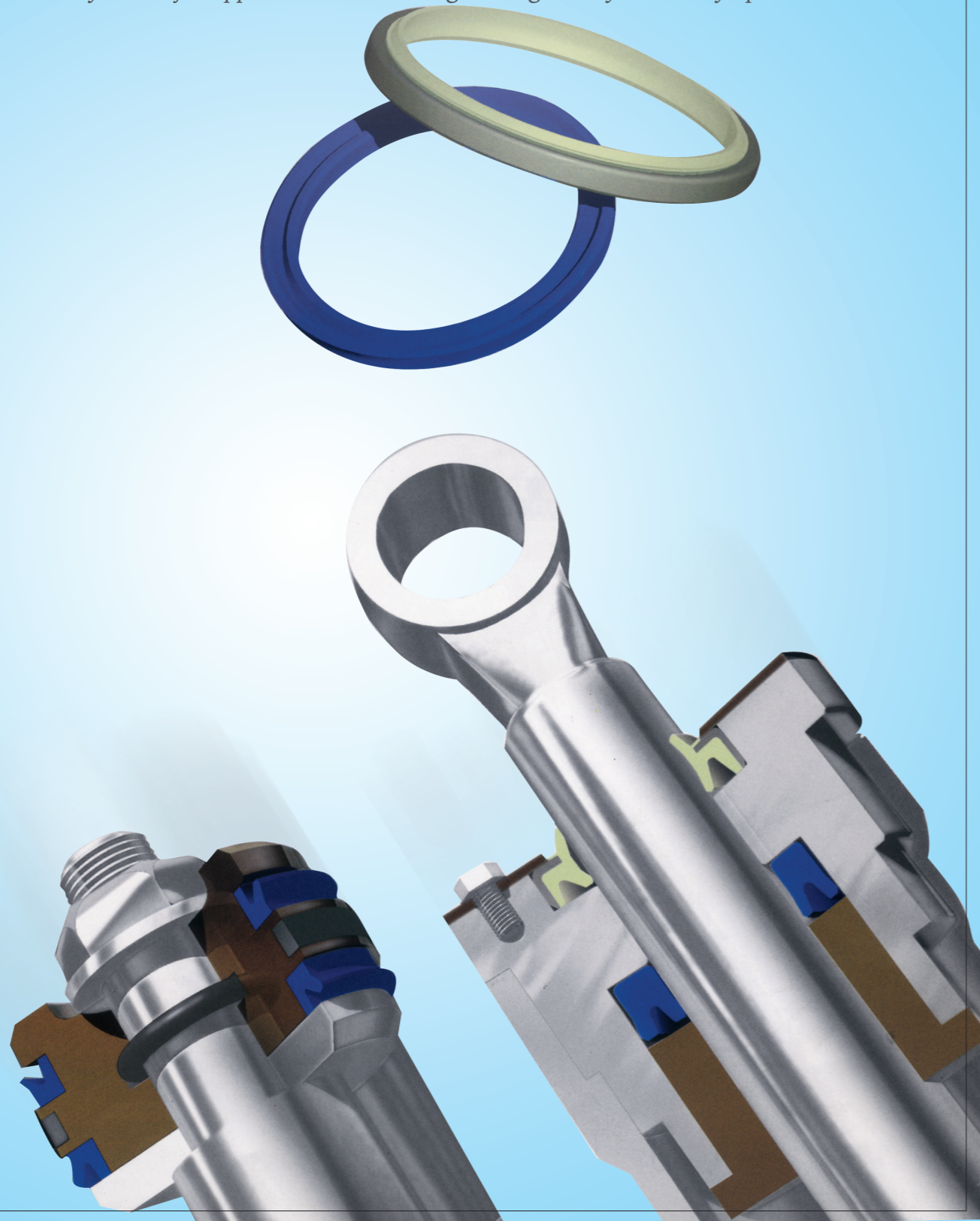

2-7 U-Seal

U-seals can be used for Heavy-duty, Medium-duty and Light-duty. Besides, we have two **different dust wipers**. One is high-grade dust wiper with support on the lower side without metal case, and the other one is high-grade dust wiper with metal case. With their superior functions in resist grease leakage and dust, both items are your one-and-only choice for application in Civil Engineering and hydraulically operated units.

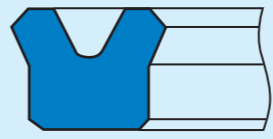
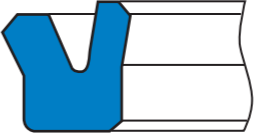
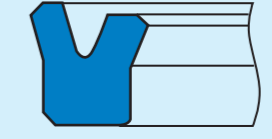

SO GIANT OIL SEAL

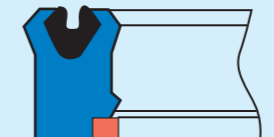
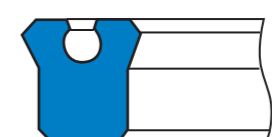
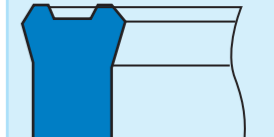
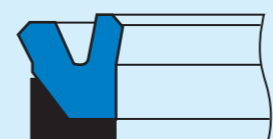
U-Seal (TPU)

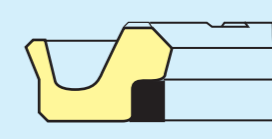
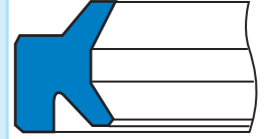
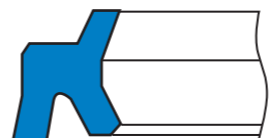
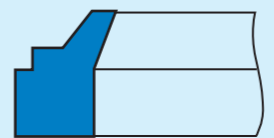
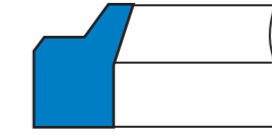
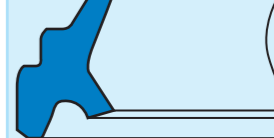
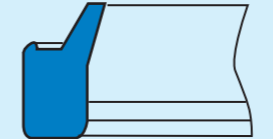
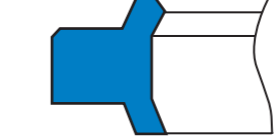
 UN	 D-1	 D-2	 D-3
 D-4	 D-5	 D-6	 D-7
 D-8	 D-9	 D-10	 DH
 DH-3	 DH-4	 DH-5	 DH-7
 DH-8	 DH-9		



U-Seal (TPU)

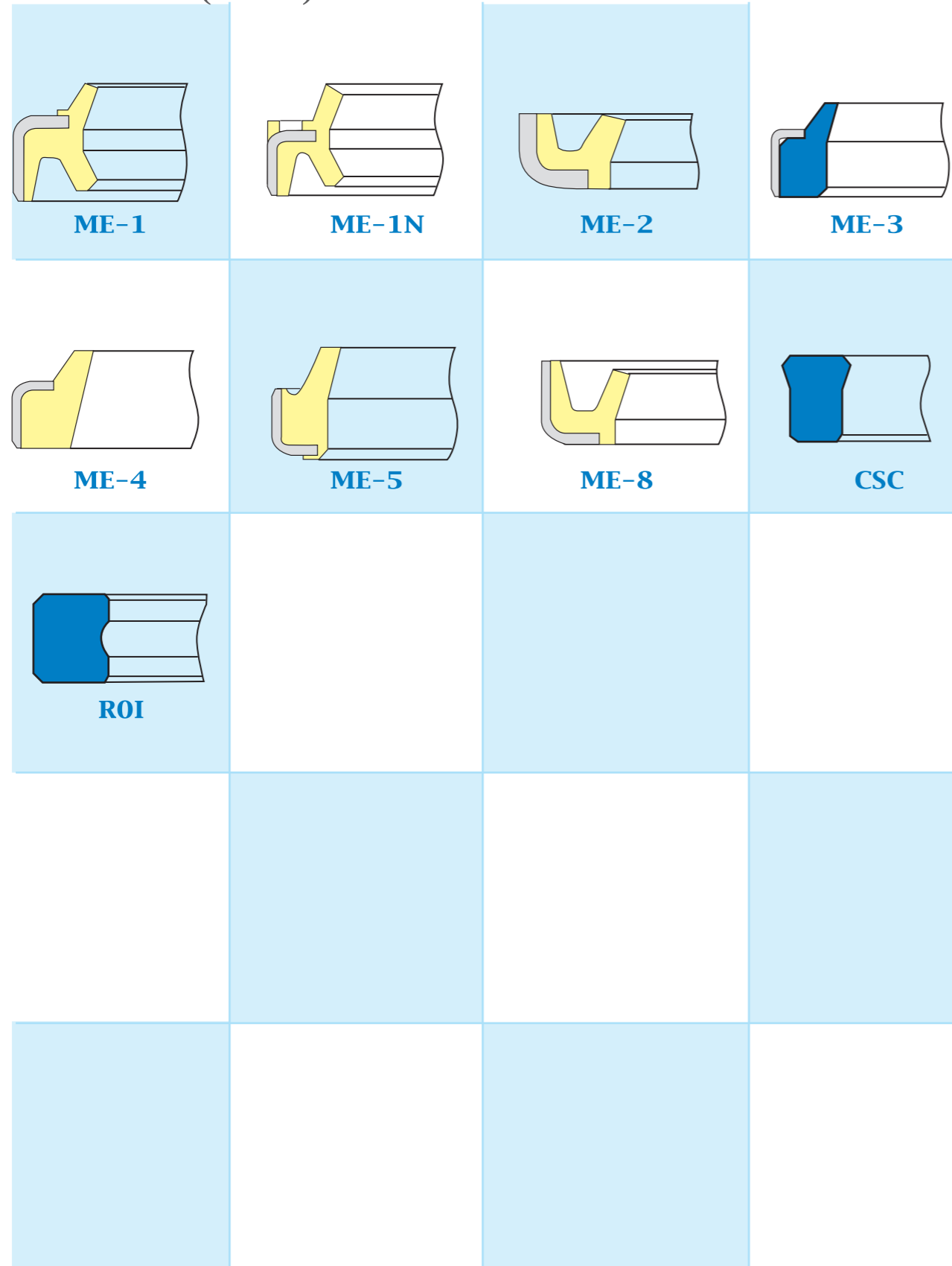

3. Sealing Elements

The demands made on the material must take into account the environmental conditions and the function of the seals.

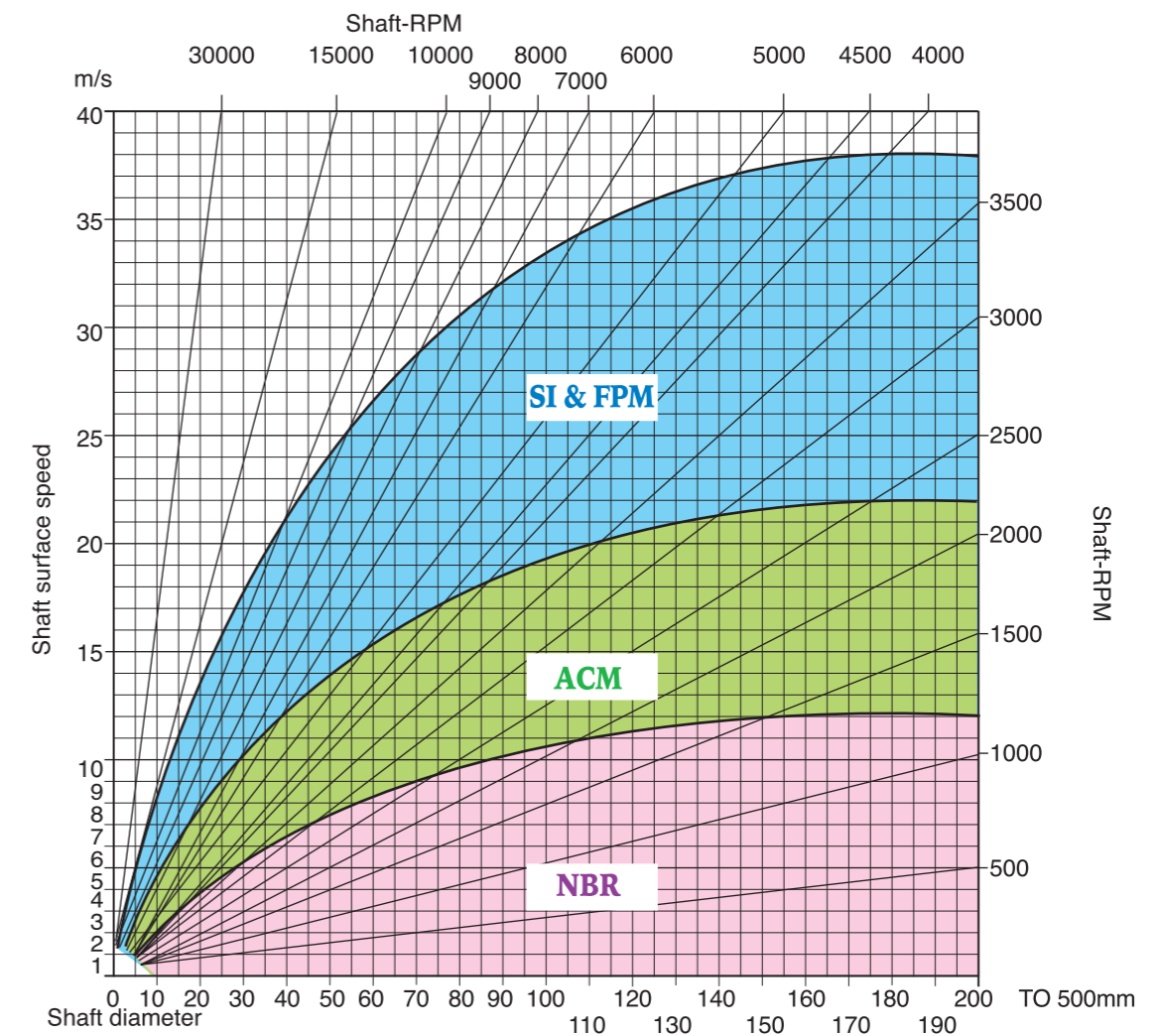

3-1 Nitrile rubber (NBR, BUNA)

ADVANTAGES:

- * Good oil and fuel resistance.
- * Good heat resistance up to 120°C in oil.
- * High tensile strength.
- * Low swelling in water.

LIMITATIONS:

- * Poor weather and ozone resistance.
- * Poor resistance against polar fluids.
- * Poor resistance against chlorinated hydrocarbon.
- * Poor resistance against aromatic fluids.



3-2 Polyacrylate rubber(ACM)

ADVANTAGES:

- * Good oil and fuels resistance.
- * Good heat resistance up to 150°C in oil.
- * Good weather and ozone resistance.

LIMITATIONS:

- * Not usable in contact with water and water solutions.
- * Limited cold flexibility.
- * Limited tensile strength and tear resistance.
- * Poor wear resistance.
- * Poor resistance against polar and aromatic fluid and chlorinated hydrocarbons.

3-3 Silicone rubber(MVQ)

ADVANTAGES:

- * Good heat resistance up to 180°C
- * Best heat resistance of all rubber types.
- * Best cold resistance of all rubber types.
- * Excellent weather and ozone resistance.

LIMITATIONS:

- * Poor tensile and tear strength.
- * Poor wear resistance.
- * Sensitive to hydrolysis.
- * Poor resistance against aromatic oils and oxidized mineral oils.
- * Poor diffusion resistance.

3-4 Fluorinated rubber(FPM)

ADVANTAGES:

- * Good heat resistance up to 200°C
- * The resistance against oil and fuels is better than other rubber types.
- * The only highly elastic rubber which is resistant to aromatic and chlorinated hydrocarbons.
- * Excellent heat resistance.
- * Excellent weather and ozone resistance.
- * Excellence acid resistance.
- * Low swelling in water.

LIMITATIONS:

- * Limited cold flexibility.
- * Limited tensile and tear strength.
- * Limited wear resistance.
- * High compression set in hot water.
- * Poor resistance to polaric solvents.

** In addition to the above sealing elements, EPDM, NEOPRENE, PTFE, and FELT are on special request.



4. Tolerance Tables

4-1 Press fit tolerance of seal outer diameter in inch and millimeter

INCH:

BORE DIAMETER	PRESS-FIT ALLOWANCE		TOLERANCE	
	METAL CASE	RUBBER OD	METAL CASE	RUBBER OD
UNDER 1.000	+0.004	+0.006	+/-0.002	+/-0.003
1.001-2.000	+0.004	+0.007	+/-0.002	+/-0.003
2.001-3.000	+0.004	+0.008	+/-0.002	+/-0.003
3.001-4.000	+0.005	+0.010	+/-0.002	+/-0.004
4.001-6.000	+0.005	+0.010	+0.003 -0.002	+/-0.004
6.001-8.000	+0.006	+0.010	+0.004 -0.002	+/-0.004
8.001-10.000	+0.008	+0.010	+0.006 -0.002	+/-0.004
10.001-2.000	+0.008	+0.010	+0.010 -0.002	+/-0.004

MILLIMETER:

BORE DIAMETER	METAL CASE	RUBBER OD
UNDER 50.00	+0.10 / +0.20	+0.15 / +0.30
50.01-80.00	+0.13 / +0.23	+0.20 / +0.35
80.01-120.00	+0.15 / +0.25	+0.20 / +0.35
120.01-180.00	+0.18 / +0.28	+0.25 / +0.45
180.01-315.00	+0.20 / +0.30	+0.25 / +0.45
315.00-500.00	+0.23 / +0.35	+0.30 / +0.55



SO GIANT OIL SEAL

4-2 Width tolerance of seal

INCH	TOLERANCE	MILLIMETER	TOLERANCE
UNDER 0.313	+ / -0.008	UNDER 8	+ / -0.20
0.314-0.472	+ / -0.012	8.01-12	+ / -0.30
0.473-0.709	+ / -0.016	12.01-18	+ / -0.40
OVER 0.710	+ / -0.020	OVER 18	+ / -0.50

4-3 Press fit allowance and permissible eccentricity of seal outer diameter in millimeter

BORE DIAMETER	PRESS-FIT ALLOWANCE		PERMISSIBLE ECCENTRICITY
	METAL CASE	RUBBER OD	
UNDER 50	+0.10 / +0.20	+0.15 / +0.30	0.25
50.1-80	+0.13 / +0.23	+0.20 / +0.35	0.35
80.1-120	+0.15 / +0.25	+0.20 / +0.35	0.50
120.1-180	+0.18 / +0.28	+0.25 / +0.45	0.65
180.1-300	+0.20 / +0.30	+0.25 / +0.45	0.80
300.1-500	+0.23 / +0.35	+0.30 / +0.55	1.00